



Rama combines a minimalist, European aesthetic with a wide range of performance characteristics. Light engine options scale from 1,500lm to 18,000lm and a wide selection of distribution types. Single or multiple luminaires can be mounted at different heights and orientations on a single pole, addressing needs of the environment whether pedestrian, vehicular or both

Housing & Materials

Rama is completely reengineered to offer a simplified installation and maintenance process; All electrical components are accessible via the hinged door assembly on the underside. High pressure die cast aluminum construction with tempered glass lens. All hardware is stainless steel. Luminaire is IP66 rated.

Electrical

120V - 277V, 50/60 Hz electronic driver. 0-10V dimming as standard (DALI dimmable upon request). -40°C start temperature. Optional control inputs include NEMA 7-pin receptacle (included, for field installation on the pole cap) or luminaire integrated photo-motion sensor).

Light Engine

High powered LEDs mounted to a RoHS compliant circuit board with PMMA optics affixed to each LED on the board. Available in 2700K, 3000K, and 4000K. >80 CRI across all available color temperatures. Luminaires meet or exceed TM21 L70: >60,000 hrs.

Distributions

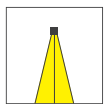

TI

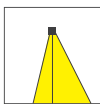

TII

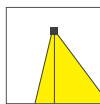

TIII

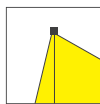

TIV

Warranty

Urbidermis guarantees the composition and performance features of all material that shape the product for a period of three years. Electrical components including LED boards and electronic drivers are guaranteed for a period of five years.

Certification

UL Listed for Wet Location, CE, RoHS Complaint, International Dark Sky Approved, Full Cutoff



Designed by Gonzalo Mila for Urbidermis

Specification Sheet | RAL

Specification

Luminaire #1 _____

Luminaire #2 _____

(If Applicable)

Mounting Bracket _____

Pole _____

(May include arms, base covers, GFCI, NEMA7 Socket, etc.)

Luminaire

Product	LED Configuration	Drive Current	Color Temperature	Distribution	Lens	Photo/Motion Sensor	Powdercoat
RAL	12 (12 LED)	A (350mA)	1 (3000K)	T1 (Type 1)	Null (Clear)	NMS (No Motion Sensor)	See powdercoat color options on the Material / Colors Sheet.
	24 (24 LED)	B (500mA)	2 (4000K)	TII (Type 2)			
	48 (48 LED)	C (700mA)	3 (2700K)	TIII (Type 3)	O (Opal/ Diffused)	MS1 (With Motion Sensor)	
	72 (72 LED)			TIV (Type 4)			

Example: RAL – 12 – B – 1 – TII – O – MS1 – MBK

Mounting Bracket

Product	Bracket	Powdercoat
RAA	01 (Single Mount)	See powdercoat color options on the Material / Colors Sheet.
	02 (Double Mount)	
	06 (Tenon Retrofit Mount)	

Example: RAA – 01 – MBK

Specification Sheet | RAL

Pole

Part Number	Twist Lock	Powdercoat	Pole Height	Pole Diameter
RAF11 <i>(1) or (2) Luminaires at Top</i>			14.8 ft (4.5m)	Straight 5" (127mm)
RAF21 <i>(1) or (2) Luminaires at Top</i>			19.7 ft (6.0m)	Straight 5" (127mm)
RAF31 <i>(2) Staggered luminaires</i>			19.7 ft (6.0m)	Straight 5" (127mm)
RAF51 <i>(1) or (2) Luminaires at Top</i>	TW1 <i>(Twist Lock Receptacle)</i>	See powdercoat color options on the Material / Colors Sheet.	26.2 ft (8.0m)	Stepped 6" (177.8mm) / 5" (127mm)
RAF62 <i>(2) Staggered luminaires</i>			26.2 ft (8.0m)	Stepped 6" (177.8mm) / 5" (127mm)
RAF71 <i>(5) Luminaire Spiral</i>	NTW <i>(No Receptacle)</i>		26.2 ft (8.0m)	Stepped 6" (177.8mm) / 5" (127mm)
RAF81 <i>(1) or (2) Luminaires at Top</i>			29.5 ft (9.0m)	Stepped 7" (177.8mm) / 5" (127mm)
RAF83 <i>(2) Staggered luminaires</i>			29.5 ft (9.0m)	Stepped 7" (177.8mm) / 5" (127mm)
RAF83 <i>(2) Staggered luminaires</i>			29.5 ft (9.0m)	Stepped 7" (177.8mm) / 5" (127mm)
RAF86 <i>(5) Luminaire Spiral</i>			29.5 ft (9.0m)	Stepped 7" (177.8mm) / 5" (127mm)

Example: RAF11 - TW1 - MBK

Modifications

Part Number	Modification	Description
CAM	Camera	
SPE	Speaker	
WAP	WiFi Access Point	
BAN	Banner Arms	
VIB	Vibration Dampener	
CPH	Custom Pole Height	
CLH	Custom Lens Height	
CPC	Custom Powdercoat Color	
--	Other	

Modifications listed above are the most common changes/additions requested. If your requirements aren't shown here, select 'other' and write in the modification needed. Please provide as much detail as possible to streamline the quoting process. All modifications to standard products will require evaluation and quoting approved by Landscape Forms prior to order placement.

Pole Height & Configuration Selection Guide

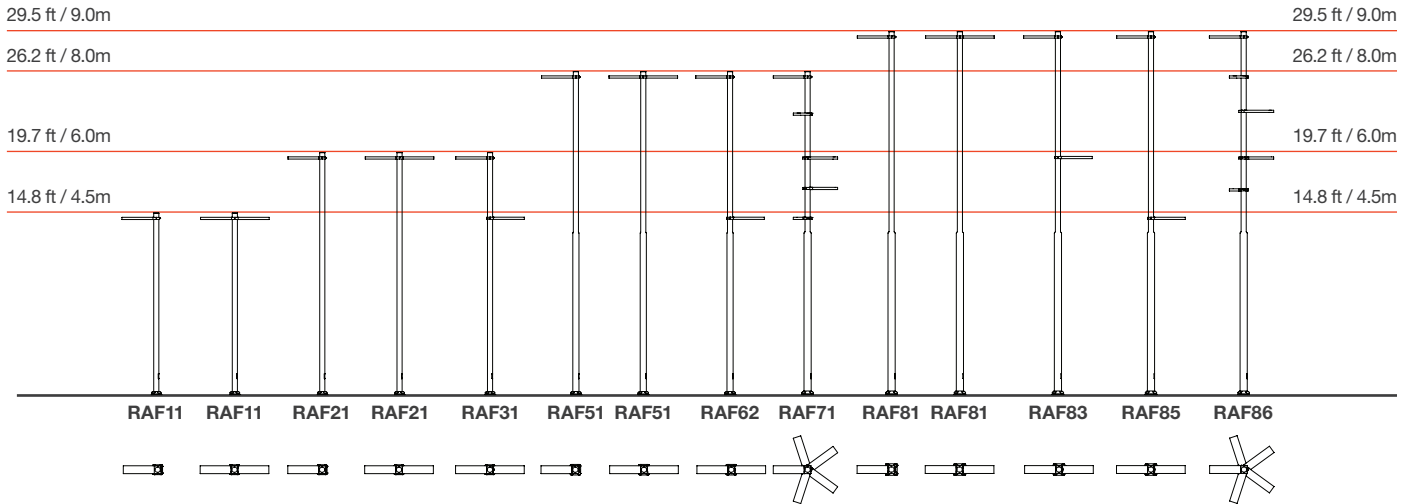

See customer drawings for luminaire mounting height details.

Poles

Straight round or stepped poles (depending on height) are manufactured from seamless aluminum alloy. Flush mounted hand hole cover includes two magnicoated fasteners. Base plate is cast aluminum A356 alloy heat treated to a T6 temper and includes four cast aluminum nut covers. Mounting template and anchor hardware also included. Anchor bolts conform to ASTM F1554 Grade 55 and are provided with two hex nuts and two flat washers. Bolts have an "L" bend on one end and are galvanized a minimum of 12" on the threaded end.

Pole Options

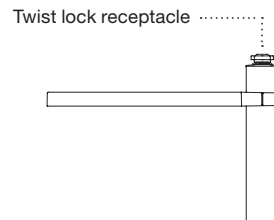

Specification Sheet | RAL

Dimensions, Weights and EPA's

Luminaire Dimensions

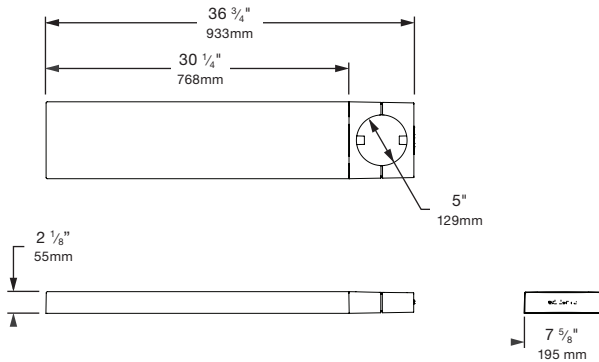

LED configurations

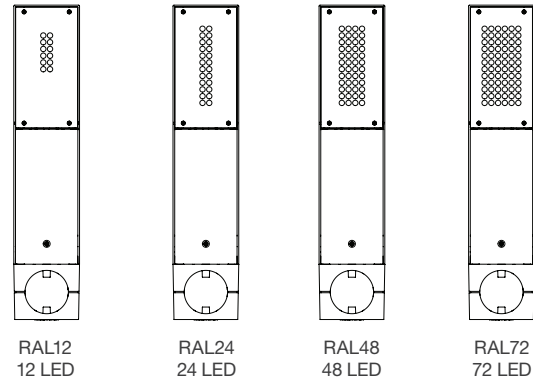

Rama Luminaire

Weight: 20lbs (luminaire only)

EPA: 1.06ft²

Mounting

The luminaire attaches to a 5" diameter section of pole using a cast aluminum two-piece compression clamp. For single mount applications, a cast aluminum back clamp is secured to the luminaire using stainless steel screws. For double mount applications, the luminaires are mounted directly (back-to-back) to each other. For tenon mount retrofit applications, the luminaire slip fits a 2-3/8 O.D. tenon and is secured by 6 stainless steel set screws.

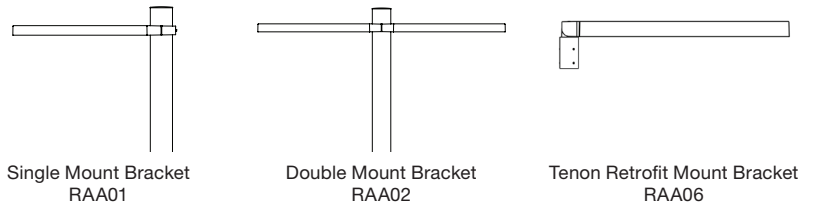

Control Options - Luminaire Mounted

PIR Photo/Motion Sensor
Integrated in luminaire

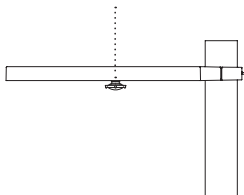

Specification Sheet | RAL

Luminaire Performance Data

Clear Lens

Color Temp	LED Quantity	Drive Current	Distribution	Lumen Output*	Efficacy*	Watts	BUG Rating
2700K 80 CRI	12	350mA	TI	1349	95	14	B1-U0-G1
			TII	1481	105	14	B1-U0-G1
			TIII	1394	99	14	B0-U0-G0
			TIV	1450	103	14	B0-U0-G0
		500mA	TI	1835	91	20	B1-U0-G1
			TII	2014	100	20	B1-U0-G1
			TIII	1897	94	20	B0-U0-G0
			TIV	1973	98	20	B1-U0-G1
		700mA	TI	2392	84	28	B1-U0-G1
			TII	2624	92	28	B1-U0-G1
			TIII	2471	87	28	B1-U0-G1
			TIV	2571	91	28	B1-U0-G1
	24	350mA	TI	2656	99	27	B1-U0-G1
			TII	2914	109	27	B1-U0-G1
			TIII	2744	103	27	B1-U0-G1
			TIV	2854	107	27	B1-U0-G1
		500mA	TI	3612	95	38	B2-U0-G2
			TII	3963	104	38	B2-U0-G2
			TIII	3732	98	38	B1-U0-G1
			TIV	3882	102	38	B1-U0-G1
700mA		TI	4707	87	54	B2-U0-G2	
		TII	5165	96	54	B2-U0-G2	
		TIII	4864	90	54	B1-U0-G1	
		TIV	5059	94	54	B1-U0-G1	

This data is subject to change.

*Apply 0.93 multiplier for opal / diffused lens option.

Specification Sheet | RAL

Luminaire Performance Data (cont.)

Clear Lens

Color Temp	LED Quantity	Drive Current	Distribution	Lumen Output*	Efficacy*	Watts	BUG Rating
2700K 80 CRI	48	350mA	TI	5366	105	51	B2-U0-G2
			TII	5888	115	51	B2-U0-G2
			TIII	5545	108	51	B1-U0-G1
			TIV	5769	113	51	B1-U0-G1
		500mA	TI	7299	100	73	B3-U0-G3
			TII	8009	109	73	B3-U0-G3
			TIII	7542	103	73	B1-U0-G1
			TIV	7845	108	73	B2-U0-G2
		700mA	TI	9811	92	103	B3-U0-G3
			TII	10437	101	103	B3-U0-G3
			TIII	9828	95	103	B2-U0-G2
			TIV	10223	99	103	B3-U0-G3
	72	350mA	TI	7924	103	77	B3-U0-G3
			TII	8695	112	77	B3-U0-G3
			TIII	8189	106	77	B1-U0-G1
			TIV	8518	111	77	B2-U0-G2
		500mA	TI	10779	98	110	B3-U0-G3
			TII	11827	107	110	B3-U0-G3
			TIII	11138	101	110	B2-U0-G2
			TIV	11586	105	110	B2-U0-G2
700mA	TI	14046	90	156	B3-U0-G3		
	TII	15412	99	156	B3-U0-G3		
	TIII	14514	93	156	B2-U0-G2		
	TIV	15097	97	156	B3-U0-G3		

This data is subject to change.

*Apply 0.93 multiplier for opal / diffused lens option.

Specification Sheet | RAL

Luminaire Performance Data (cont.)

Clear Lens

Color Temp	LED Quantity	Drive Current	Distribution	Lumen Output*	Efficacy*	Watts	BUG Rating
3000K 80 CRI	12	350mA	TI	1349	95	14	B1-U0-G1
			TII	1481	105	14	B1-U0-G1
			TIII	1394	99	14	B0-U0-G0
			TIV	1450	103	14	B0-U0-G0
		500mA	TI	1835	81	20	B1-U0-G1
			TII	2014	100	20	B1-U0-G1
			TIII	1897	94	20	B0-U0-G0
			TIV	1973	98	20	B1-U0-G1
		700mA	TI	2392	84	28	B1-U0-G1
			TII	2624	92	28	B1-U0-G1
			TIII	2471	87	28	B1-U0-G1
			TIV	2571	91	28	B1-U0-G1
	24	350mA	TI	2656	99	27	B1-U0-G1
			TII	2914	109	27	B1-U0-G1
			TIII	2744	103	27	B1-U0-G1
			TIV	2854	107	27	B1-U0-G1
		500mA	TI	3614	95	38	B2-U0-G2
			TII	3963	104	38	B2-U0-G2
			TIII	3732	98	38	B1-U0-G1
			TIV	3882	102	38	B1-U0-G1
700mA		TI	4707	87	54	B2-U0-G2	
		TII	5165	96	54	B2-U0-G2	
		TIII	4864	90	54	B1-U0-G1	
		TIV	5059	94	54	B1-U0-G1	

This data is subject to change.

*Apply 0.93 multiplier for opal / diffused lens option.

Specification Sheet | RAL

Luminaire Performance Data (cont.)

Clear Lens

Color Temp	LED Quantity	Drive Current	Distribution	Lumen Output*	Efficacy*	Watts	BUG Rating
3000K 80 CRI	48	350mA	TI	5366	105	51	B2-U0-G2
			TII	5888	115	51	B2-U0-G2
			TIII	5545	108	51	B1-U0-G1
			TIV	5768	113	51	B1-U0-G1
		500mA	TI	7299	100	73	B3-U0-G3
			TII	8099	109	73	B3-U0-G3
			TIII	7542	103	73	B1-U0-G1
			TIV	7845	108	73	B2-U0-G2
		700mA	TI	9511	92	103	B3-U0-G3
			TII	10437	101	103	B3-U0-G3
			TIII	9828	95	103	B2-U0-G2
			TIV	10223	99	103	B2-U0-G2
	72	350mA	TI	7924	103	77	B3-U0-G3
			TII	8695	112	77	B3-U0-G3
			TIII	8189	106	77	B1-U0-G1
			TIV	8518	111	77	B2-U0-G2
		500mA	TI	10779	98	110	B3-U0-G3
			TII	11827	107	110	B3-U0-G3
			TIII	11138	101	110	B2-U0-G2
			TIV	11586	105	110	B2-U0-G2
700mA	TI	14046	90	156	B3-U0-G3		
	TII	15412	99	156	B3-U0-G3		
	TIII	14541	93	156	B2-U0-G2		
	TIV	15097	97	156	B3-U0-G3		

This data is subject to change.

*Apply 0.93 multiplier for opal / diffused lens option.

Specification Sheet | RAL

Luminaire Performance Data (cont.)

Clear Lens

Color Temp	LED Quantity	Drive Current	Distribution	Lumen Output*	Efficacy*	Watts	BUG Rating
4000K 80 CRI	12	350mA	TI	1552	112	14	B1-U0-G1
			TII	1703	122	14	B1-U0-G1
			TIII	1604	115	14	B0-U0-G0
			TIV	1668	120	14	B1-U0-G1
		500mA	TI	2111	106	20	B1-U0-G1
			TII	2316	117	20	B1-U0-G1
			TIII	2181	110	20	B1-U0-G1
			TIV	2269	115	20	B1-U0-G1
		700mA	TI	2751	98	28	B1-U0-G1
			TII	3018	108	28	B1-U0-G1
			TIII	2842	102	28	B1-U0-G1
			TIV	2957	106	28	B1-U0-G1
	24	350mA	TI	3054	116	26	B2-U0-G2
			TII	3351	127	26	B2-U0-G2
			TIII	3156	120	26	B1-U0-G1
			TIV	3283	125	26	B1-U0-G1
		500mA	TI	4154	111	38	B2-U0-G2
			TII	4559	121	38	B2-U0-G2
			TIII	4293	114	38	B1-U0-G1
			TIV	4465	119	38	B1-U0-G1
700mA	TI	5414	102	53	B2-U0-G2		
	TII	5940	112	53	B2-U0-G2		
	TIII	5594	106	53	B1-U0-G1		
	TIV	5819	110	53	B1-U0-G1		

This data is subject to change.

*Apply 0.93 multiplier for opal / diffused lens option.

Specification Sheet | RAL

Luminaire Performance Data (cont.)

Clear Lens

Color Temp	LED Quantity	Drive Current	Distribution	Lumen Output*	Efficacy*	Watts	BUG Rating
4000K 80 CRI	48	350mA	TI	6172	122	50	B3-U0-G3
			TII	6772	134	50	B3-U0-G3
			TIII	6378	127	50	B1-U0-G1
			TIV	6634	132	50	B2-U0-G2
		500mA	TI	8395	117	72	B3-U0-G3
			TII	9212	128	72	B3-U0-G3
			TIII	8675	121	72	B1-U0-G2
			TIV	9023	126	72	B2-U0-G2
		700mA	TI	10939	108	102	B3-U0-G3
			TII	12004	118	102	B3-U0-G3
			TIII	11304	111	102	B2-U0-G2
			TIV	11758	116	102	B2-U0-G2
	72	350mA	TI	9114	120	76	B3-U0-G3
			TII	10001	131	76	B3-U0-G3
			TIII	9418	124	76	B2-U0-G2
			TIV	9797	129	76	B2-U0-G2
		500mA	TI	12397	114	109	B3-U0-G3
			TII	13603	125	109	B3-U0-G3
			TIII	12811	118	109	B2-U0-G2
			TIV	13325	123	109	B3-U0-G3
700mA	TI	16155	106	153	B4-U0-G4		
	TII	17727	116	153	B4-U0-G4		
	TIII	16694	109	153	B2-U0-G2		
	TIV	17364	114	153	B3-U0-G3		

This data is subject to change.

*Apply 0.93 multiplier for opal / diffused lens option.

Rama



Material / Colors Sheet | RAL

24 LED 500mA at 14'

Performance light engine @ 3000K

1.0fc 0.5fc 0.2fc

14' Lens Height, 500mA, Type I

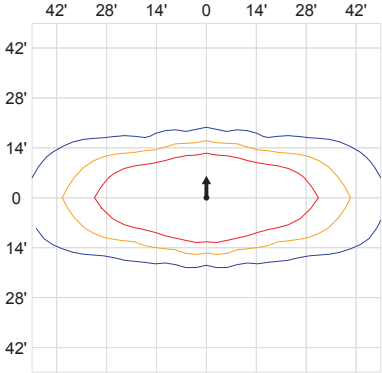

14' Lens Height, 500mA, Type II

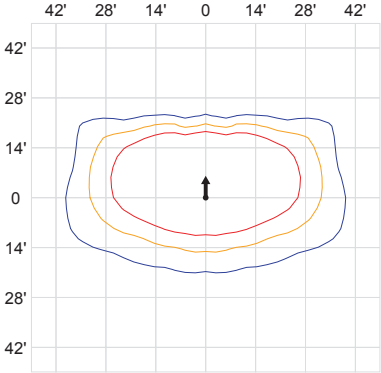

14' Lens Height, 500mA, Type III

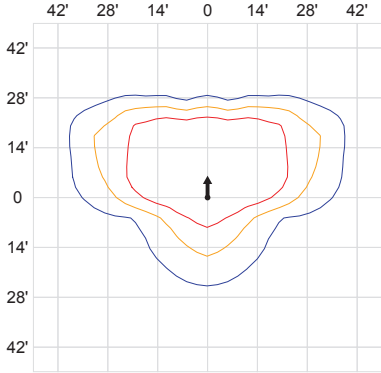

14' Lens Height, 500mA, Type IV

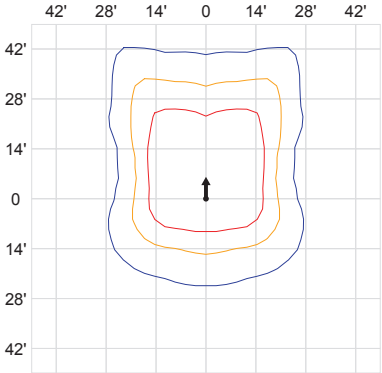

Rama

Material / Colors Sheet | RAL

48 LED 500mA at 25'

Performance light engine @ 3000K

1.0fc 0.5fc 0.2fc

25' Lens Height, 500mA, Type I

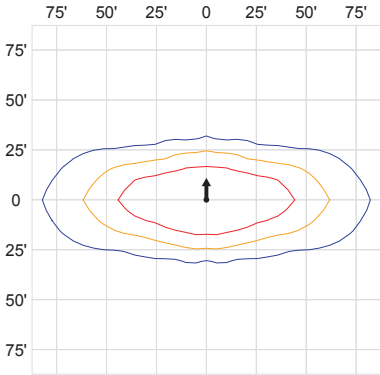

25' Lens Height, 500mA, Type II

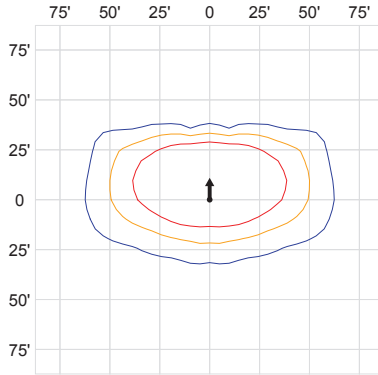

25' Lens Height, 500mA, Type III

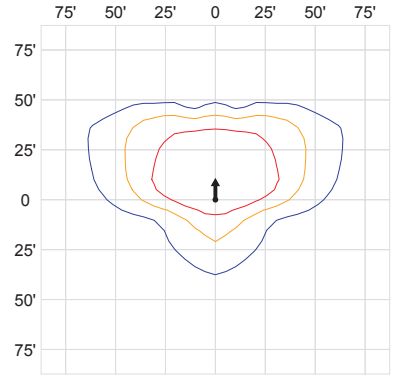

25' Lens Height, 500mA, Type IV

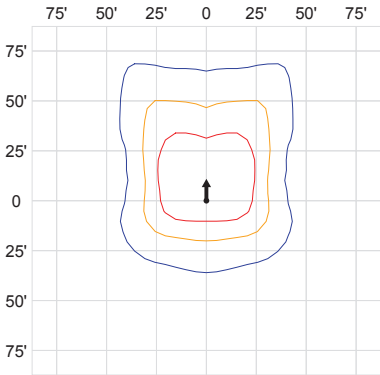

Material / Colors Sheet | RAL

Luminaire and Mounting Brackets*



ALS (Aluminum Silver) DSK (Dusk)

Neutral Series - Powdercoated Metal* (Poles Only)**



BLK (Gloss Black) SIL (Silver Metallic) TNM (Titanium Metallic) MER (Mercury Metallic)***

Architectural Series - Powdercoated Metal* (Fine Texture, Poles Only)**



MBK (Matte Black) DSK (Dusk)

Powdercoated Metal

Urbidermis luminaire and mounting brackets are powdercoated using a thermal coating finish with C3 anti-corrosive protection.

Urbidermis luminaire and mounting brackets, in addition to the poles, can be specified with Landscape Forms' Powdercoated Metal Pangard II® Polyester Powdercoat.

The Powdercoated Metal Pangard II® Polyester Powdercoat is a hard, yet flexible, finish that resists rusting, chipping, peeling and fading. In addition to colors shown, a wide selection of optional and custom colors may be specified for an upcharge.

- * Luminaire and mounting brackets colors shown are the color options offered from Urbidermis.
- ** All colors and patterns shown are approximate and may vary from sample and final.
- *** Mercury from Landscape Forms is our recommended color match for Aluminum Silver from Urbidermis.

Visit landscapeforms.com for more information. Specifications are subject to change without notice. Landscape Forms supports the Landscape Architecture Foundation at the Second Century level.
©2023 Landscape Forms, Inc.

landscapeforms.com | specify@landscapeforms.com