

Club chair

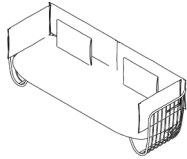

Sofa with arms

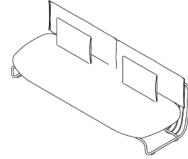

Sofa without arms

Tools Required:

- units ship assembled. No tools required for standalone pieces.

ASSEMBLY PROCEDURE: Note: Units ship fully assembled, with cushions on frames and wrapped in plastic.

1. Remove all plastic from cushions.
2. Attach seat cushions to frame using hook and loop connections, see Fig. 1.
3. Attach side and back cushions to frame using snap connections, see Fig. 3. Straps should wrap around 2 vertical bars on the frame of the unit.
4. Set accessory pillows in position.

Cushions and pillows should be placed in position with the zipper on the bottom, and the connecting straps toward the outside. Seat cushions should be installed with the zipper in the back and the hook and loop straps on the bottom, at the front of the unit.

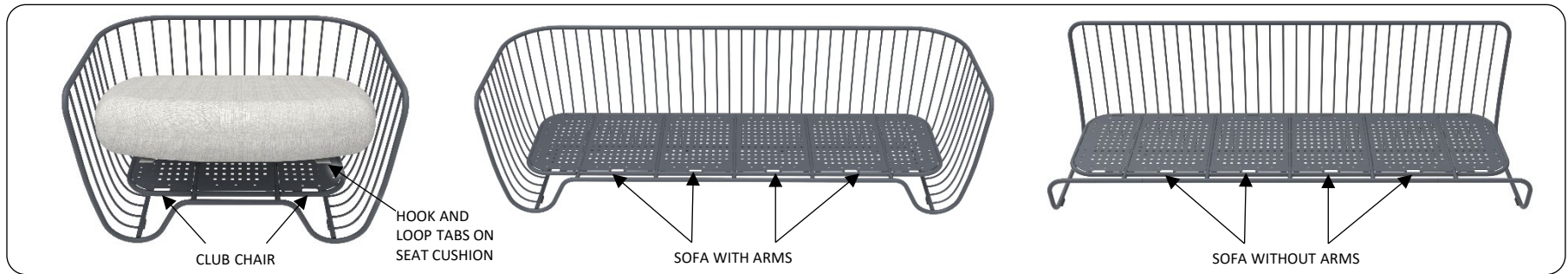

FIG 1 – SEAT CUSHION ATTACHMENT POINTS

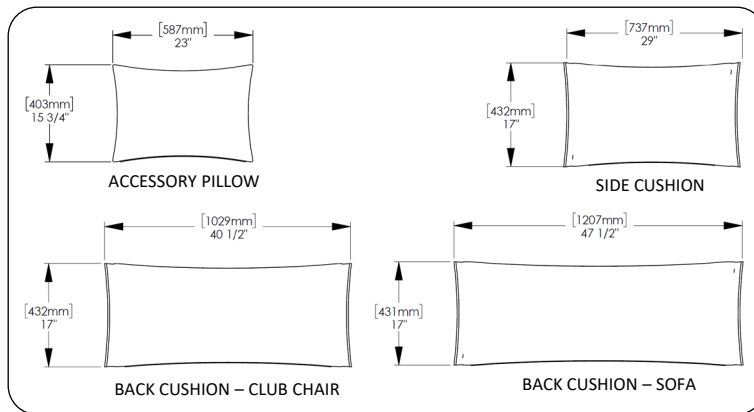

FIG 2 – CUSHION SIZES

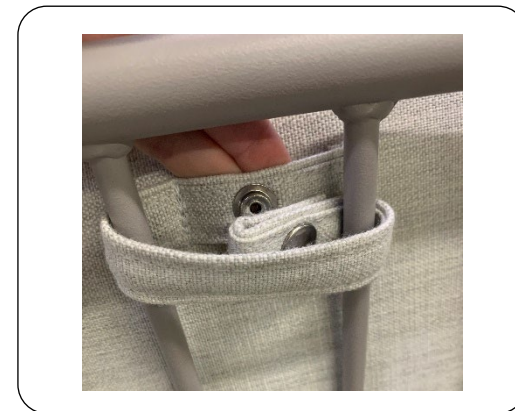
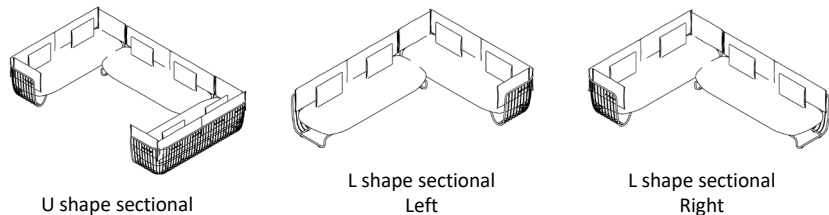
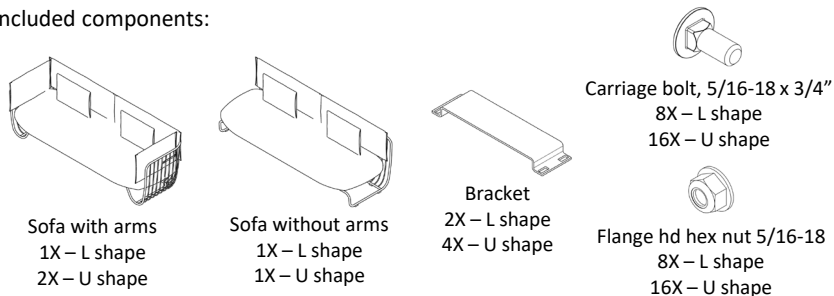

FIG 3 – SIDE / BACK CUSHION ATTACHMENT

ASSEMBLE WITH CARE! Pangard II® Polyester Powdercoat is a strong, long-lasting finish. To protect this finish during assembly, place unwrapped powdercoated parts on packaging foam or other non-marring surface. Do not place or slide powdercoated parts on concrete or other hard or textured surface – this will damage the finish causing rust to occur. Use touch-up paint on any gouges in the finish caused by assembly tools.



Included components:



Tools Required:

- 1/2" socket wrench

INSTALLATION PROCEDURE:

1. Set units in position. Remove accessory pillows and seat cushions and set aside.
2. Locate brackets on the sofa without arms as shown in Fig. 4. Brackets install on the bottom side of the seat pan. Insert carriage bolts from the top of the seat pan, so rounded head on bolt is at the top (and bolt will not catch on fabric of seat cushion).
3. Install flanged hex nuts, with flange closest to bracket, see Fig. 5.
4. Check alignment of the sofa frames, see Fig. 4, before attaching bracket to sofa with arms.
5. Install 2 brackets for L-shape sectional, or 4 brackets for U-shape sectional.
6. Reattach cushions.

ASSEMBLE WITH CARE! Pangard II® Polyester Powdercoat is a strong, long-lasting finish. To protect this finish during assembly, place unwrapped powdercoated parts on packaging foam or other non-marring surface. Do not place or slide powdercoated parts on concrete or other hard or textured surface – this will damage the finish causing rust to occur. Use touch-up paint on any gouges in the finish caused by assembly tools.

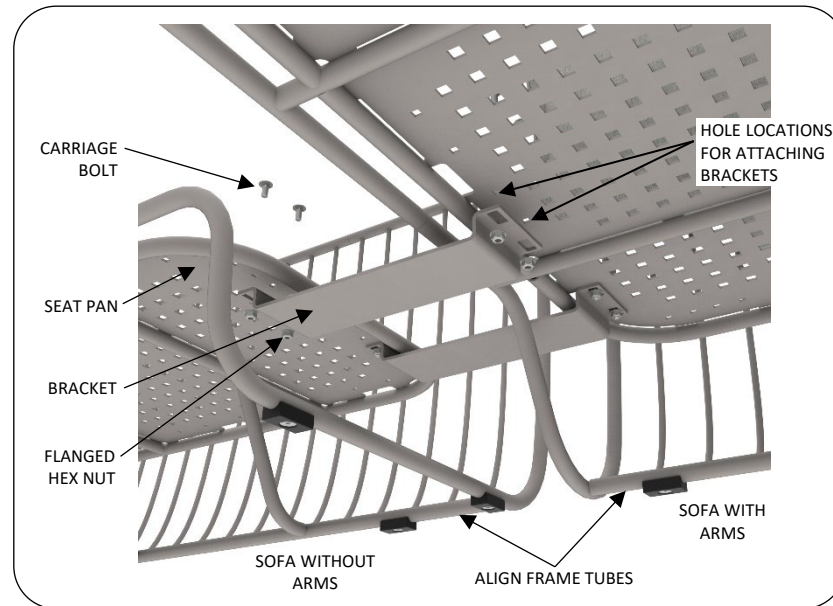

FIG 4 – BRACKET ATTACHMENT

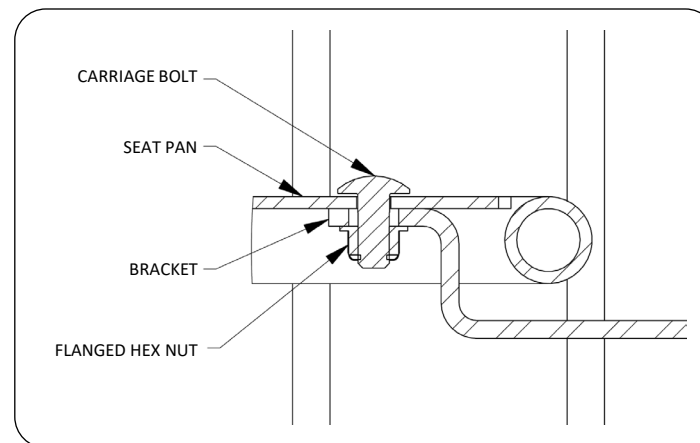

FIG 5 – BRACKET HARDWARE ASSEMBLY

INSTALLATION PROCEDURE:

1. Monterey seating may be ordered with weather covers. Size of cover differs for club chair, sofa with arms and sofa without arms.
2. Cushions should be dry and free of debris before installation of weather cover.
3. To promote water drainage off of weather cover, side cushions on club chair and sofa with arms should be unsnapped and laid flat, see Fig. 6. Club chair accessory pillow should be placed in between side cushions, see Fig. 6.
4. Place weather cover over unit, and gently pull cover down to grade. Venting on cover should be installed to the back of the unit.
5. Straps at the bottom of the cover on the front and the back should be cinched tight.
6. For install on sectional units, units can remain assembled. Install covers, tucking in excess material at the joint location.

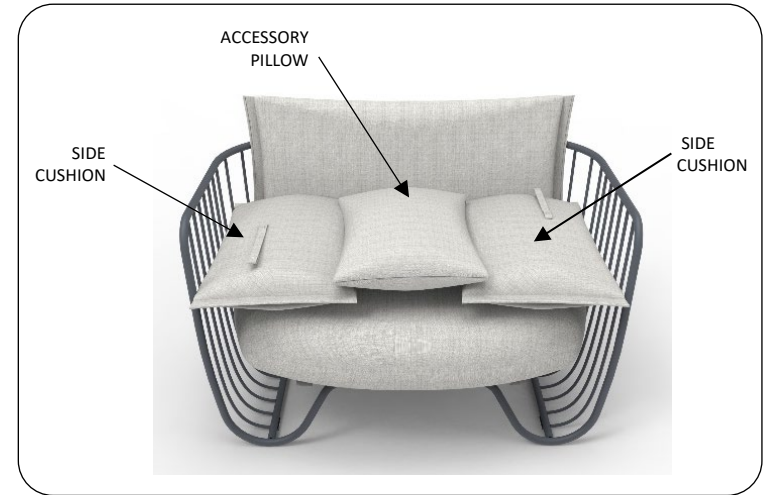

FIG 6 – CUSHION PLACEMENT FOR WEATHER COVER INSTALL

ASSEMBLE WITH CARE! Pangard II® Polyester Powdercoat is a strong, long-lasting finish. To protect this finish during assembly, place unwrapped powdercoated parts on packaging foam or other non-marring surface. Do not place or slide powdercoated parts on concrete or other hard or textured surface – this will damage the finish causing rust to occur. Use touch-up paint on any gouges in the finish caused by assembly tools.